

A compact smart camera that simplifies inspections

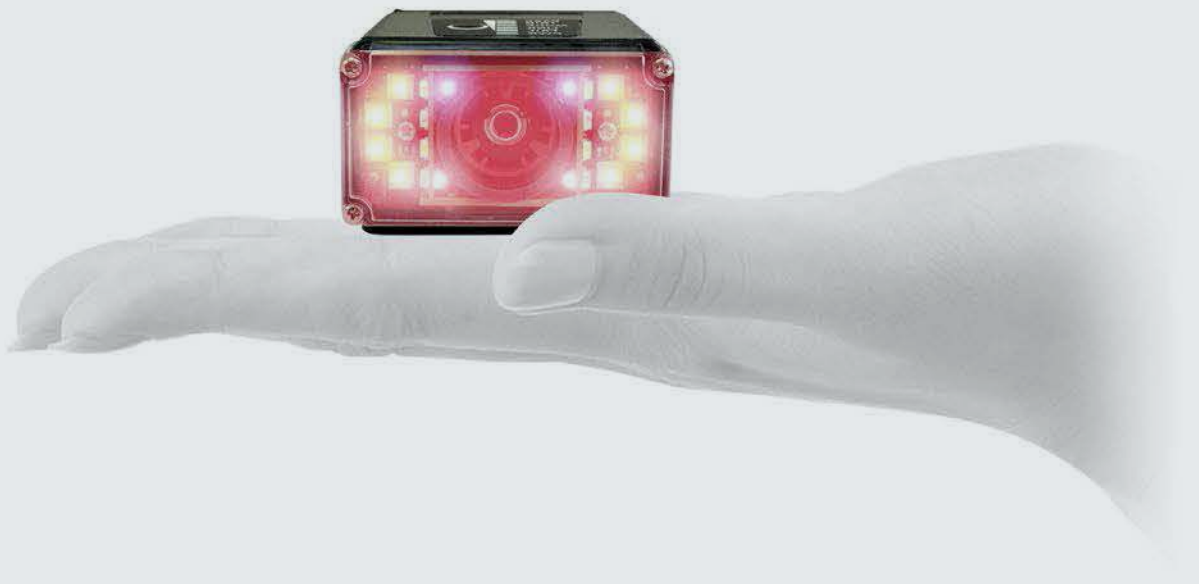

Simplify multiple-device inspection systems by using a single camera

Traditional image inspections require one or more dedicated cameras to be paired with a code reader. Omron's F430-F/F420-F Series Smart Camera bundles all this functionality into a single device, dramatically simplifying application design. The single-camera solution also reduces the initial investment, cuts down on wiring work and keeps maintenance costs to a minimum.

Inspections | 01

A single camera performing powerful inspection tasks and code reading

Inspections | 02

A single camera achieving the precision managed by multiple devices

Inspections | 03

A single camera covering multiple parts that vary in size

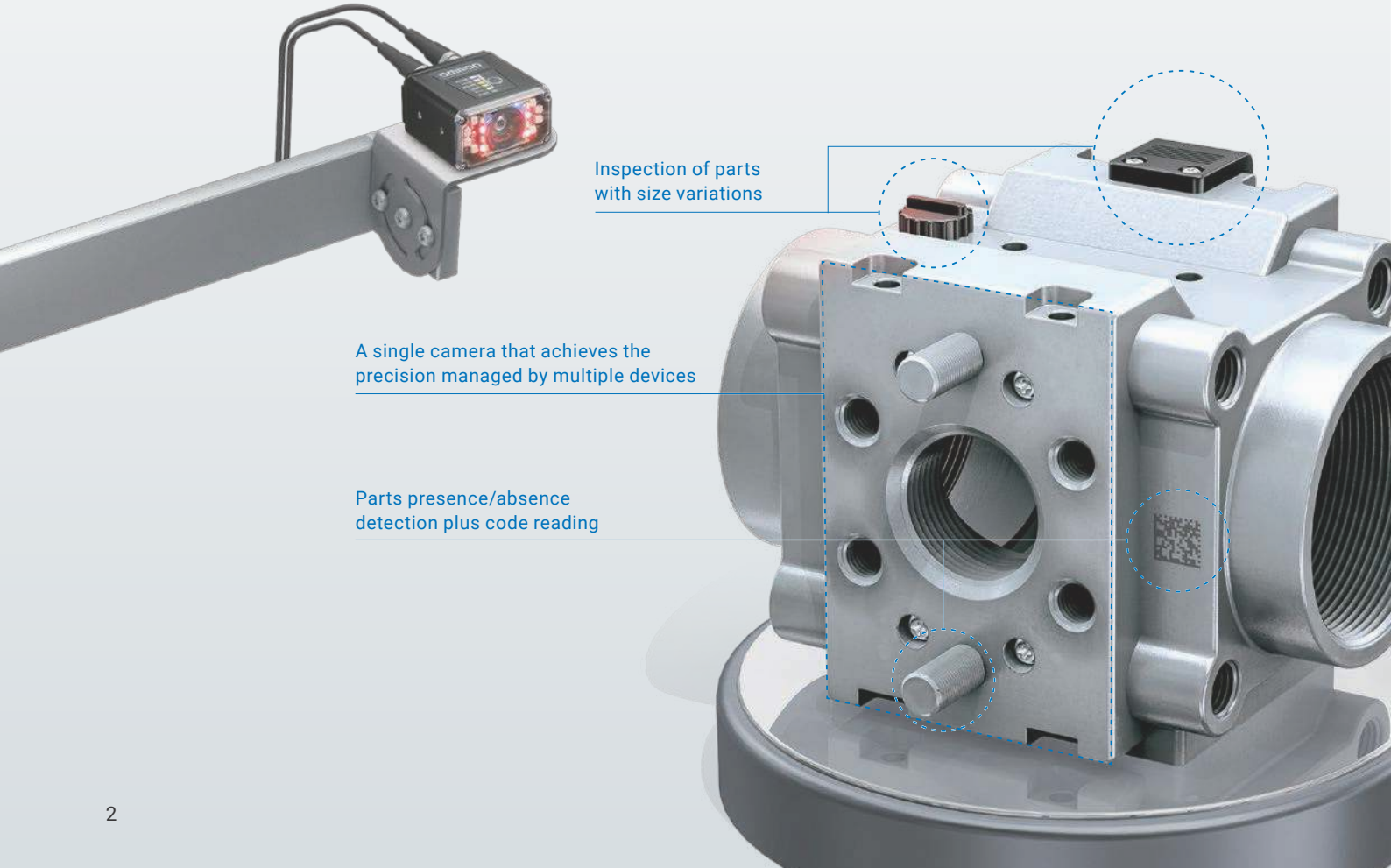

Inspection of parts with size variations

A single camera that achieves the precision managed by multiple devices

Parts presence/absence detection plus code reading

Inspections | 01

A single camera performing powerful inspection tasks and code reading

Inspection, code reading and character reading all in one

To perform a simple inspection task - such as presence/absence detection, color detection, etc. - along with a code or character reading, a highly-functional sensor or a sensor combined with a code reader for each purpose would be required. The F430-F/F420-F Series successfully performs both functions, simplifying inspection tasks overall.

Code reading



Cap presence/absence inspection

Cap present OK



Cap absent NG

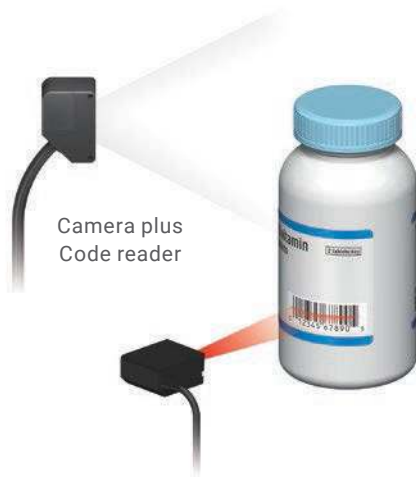

Previously, two devices were necessary: a code reader and a inspection sensor



A single camera can now perform both code reading and inspection

Applications

Digital industry applications

Presence/absence detection and code reading on PCBs

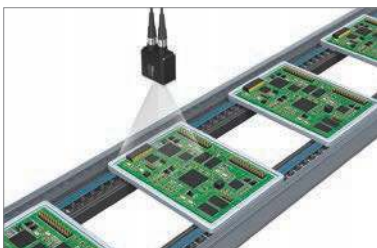

OK



NG

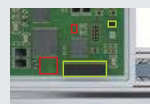

F&B and pharma industry applications

Cap inspection and code reading on pharmacy products



OK



NG



Conveyance equipment industry applications

Label direction, and both of code and character reading



OK



NG



Multiple cameras in one to enhance precision

High-resolution 5-megapixel color camera

When using low-resolution cameras, multiple cameras are needed to divide a view in several sections and achieve the resolution required for inspections. The 5-megapixel color camera of the F430-F/F420-F Series delivers high-resolution imaging of multiple points with a single device.

*1. Inspections using up to 12 color cameras with 0.3-megapixel are possible at once by a single color camera with 5-megapixel.

Inspection scope examples

0.3 Megapixel color camera:
1 PCB



5 Megapixel color camera:
8 PCBs

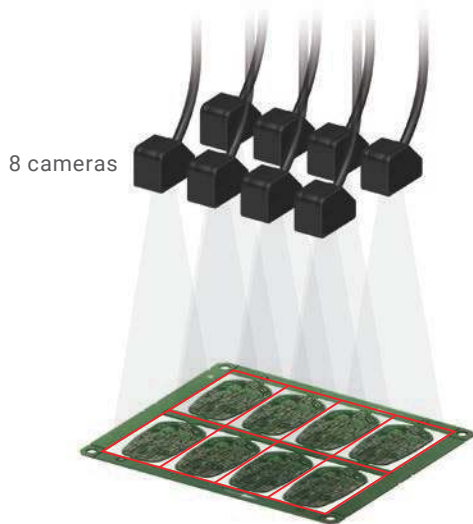

Inspection of part presence/absence with low-resolution cameras requires multiple devices.

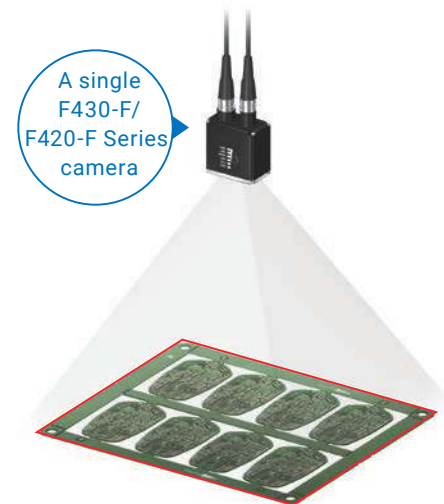

With the F430-F/F420-F Series 5MP high-resolution color camera, a single device covers all inspection needs.

Applications

Automotive industry applications

Inspections for presence/absence of Instrument panel clips



Digital industry applications

Inspections for presence/absence of substrate mount components

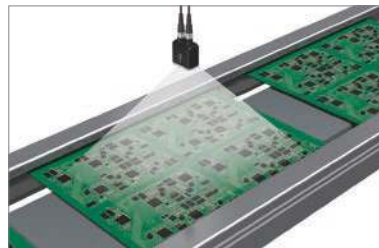

F&B and pharma industry applications

Inspections for absence of medicine on blister sheets

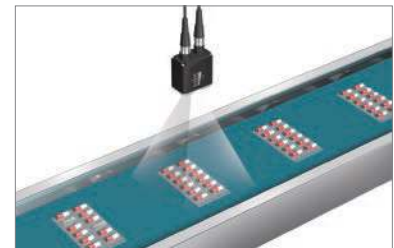

Inspections | 03

A single camera covering multiple parts that vary in size

Long life liquid autofocus lens

To inspect multiple parts that vary in size, an autofocus lens does not require multiple cameras or a mechanical structure to change camera position. In addition, its longevity is much greater than that of mechanical autofocus lenses, as these generally malfunction after repeated focus adjustments due to wear and tear on the driving part or the motor. For a liquid lens, there is no limitation on the number of focus adjustments.

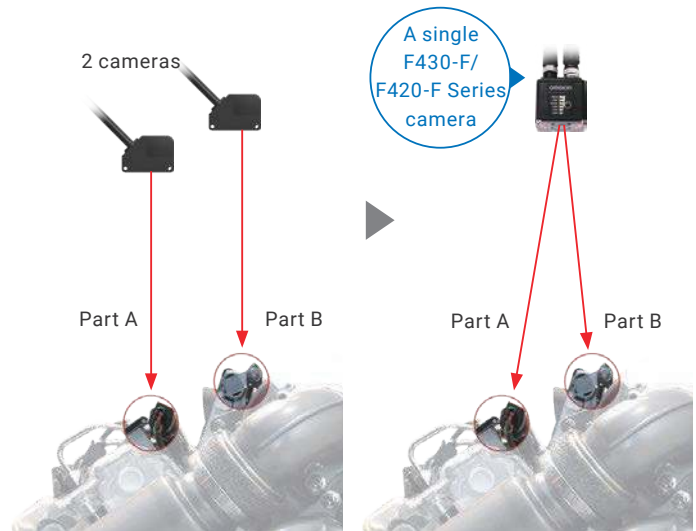

Liquid lens: How it works

For target parts with varying heights, the liquid lens on the F430-F/F420-F Series flexibly changes its focal length by applying a voltage to alter the shape of an internal oil-water interface.

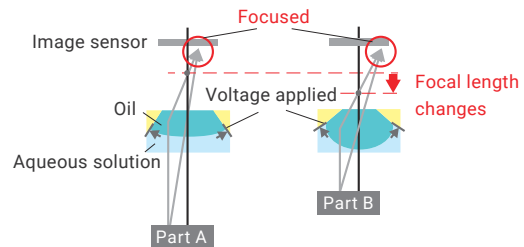

Applications

Automotive industry applications

Inspections for presence/absence of multiple bolts

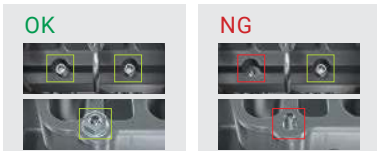

Digital industry applications

Printed letters presence/absence inspection for multiple parts that vary in size on PCBs

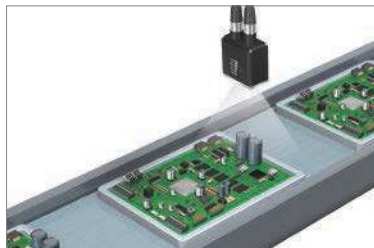

Conveyance equipment industry applications

Quantity inspections for various type of products

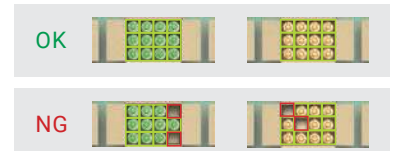
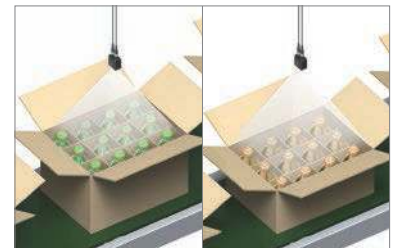

Simple to mount on small robots

The lighting module, lens and controller (sometimes referred as amplifiers) are integrated into the F430-F/F420-F's compact body, enabling it to be mounted on a small robot. There is no need to wire any cables between the camera and the amplifier in this single-device solution.

Separated amplifier type

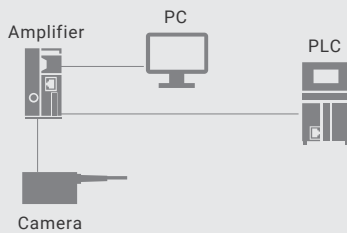

Integrated amplifier type

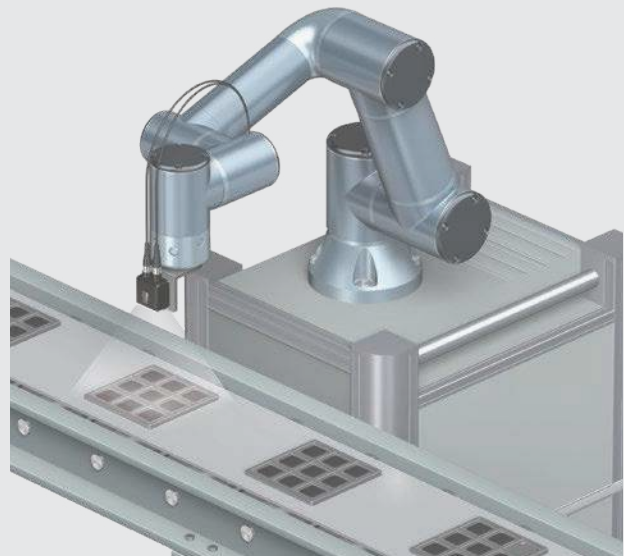
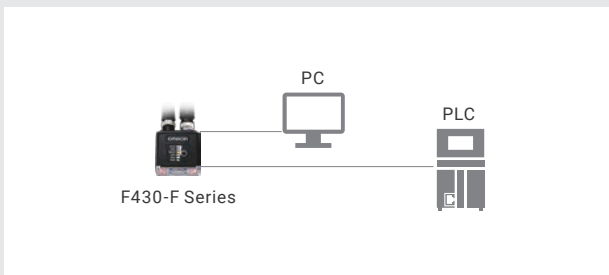

Equipped with a smart camera, the collaborative robot enables simple discriminations that can flexibly handle various objects.

Note: F430-F Series is compatible with robot cables.

A single screen makes settings adjustments easy (AutoVISION Software)

Vision Setting

Place a workpiece within a focal length and press the autofocus button to optimize the focus and brightness of the inspection image. You can also specify an inspection range and let the camera auto-adjust the image by referring the range.

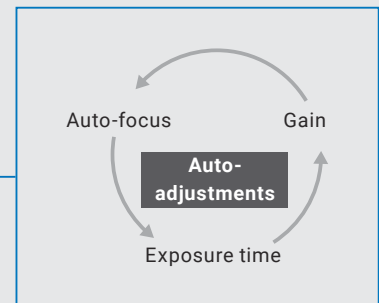

Inspection item settings

You can check the test measurement results in this screen and adjust the inspection range and the threshold by referring the screen. After the settings are completed, just press the "Execute" to complete the inspections. You can set multiple inspection items in a single screen at once and easily arrange the order of the items.

Inspection items

Inspection item batch display

Freely arrange the order by drag-and-drop

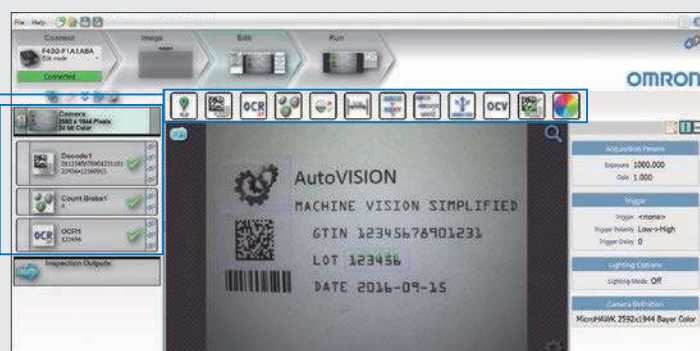

Take advantage of the F430-F/F420-F Series to perform a variety of inspection tasks with less time and effort

Choices with different I/O interfaces

- RS-232C
- Ethernet TCP/IP
- EtherNet/IP™

F430-F Series
(Catalog No.Q278)



- RS-232C
- USB
- Ethernet over USB.

F420-F Series
(Catalog No.Q279)



F330-F/F320-F Series for simpler solutions

Also available are simpler, easy-to-introduce types for the following applications. Please ask your Omron representative for details.

- Auto-focus is not necessary as the objects are of the same type with no difference in height
- Used in a dry environment, IP40 is sufficient

Choices with different I/O interfaces

- Ethernet TCP/IP

F330-F Series
(Catalog No.Q280)



- RS-232C
- Ethernet over USB

F320-F Series
(Catalog No.Q281)



Omron's vision sensor series

High
Function

High-speed high-precision alignment FH Vision System

Provides high-performance inspections and measurements beyond human vision, covering from the detection of microscopic defects to the high-speed and high-precision alignment.



High-speed appearance inspection, pre-alignment FHV7 Smart Camera

The functionality and speed enabling appearance inspection, pre-alignment, and other inspection and measurements that your production site demands are packed in an all-in-one device.



Simple discrimination F430-F/F420-F Smart Camera

Brings simple inspections such as presence/absence or direction in a single compact device without hassle.



Note: V430-F/V420-F Series can be used if only code reading is necessary.
Refer to the Code Reader Group Catalog (Cat. No. Q263) for details.

- EtherNet/IP™ is a trademark of ODVA.
- QR code is the registered trademark of DENSO WAVE.
- Other company names and product names in this document are the trademarks or registered trademarks of their respective companies.
- The product photographs and figures that are used in this catalog may vary somewhat from the actual products.

Note: Do not use this document to operate the Unit.

OMRON Corporation Industrial Automation Company
Kyoto, JAPAN

Contact: www.ia.omron.com

Regional Headquarters

OMRON EUROPE B.V.
Wegalaan 67-69, 2132 JD Hoofddorp
The Netherlands
Tel: (31)2356-81-300/Fax: (31)2356-81-388

OMRON ASIA PACIFIC PTE. LTD.
No. 438A Alexandra Road # 05-05/08 (Lobby 2),
Alexandra Technopark,
Singapore 119967
Tel: (65) 6835-3011/Fax: (65) 6835-2711

OMRON ELECTRONICS LLC
2895 Greenspoint Parkway, Suite 200 Hoffman Estates,
IL 60169 U.S.A.
Tel: (1) 847-843-7900/Fax: (1) 847-843-7787

OMRON ADEPT TECHNOLOGIES, INC.
4550 Norris Canyon Road, Suite 150, San Ramon, CA 94583 U.S.A.
Tel: (1) 925-245-3400/Fax: (1) 925-960-0590

OMRON (CHINA) CO., LTD.
Room 2211, Bank of China Tower, 200 Yin Cheng Zhong Road,
PuDong New Area, Shanghai, 200120, China
Tel: (86) 21-5037-2222/Fax: (86) 21-5037-2200

Authorized Distributor:

© OMRON Corporation 2019 All Rights Reserved.
In the interest of product improvement,
specifications are subject to change without notice.
CSM_1_2_0120

Cat. No. Q272-E1-01

1219 (1219)